

ELKE

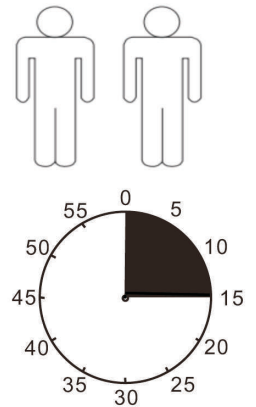

1

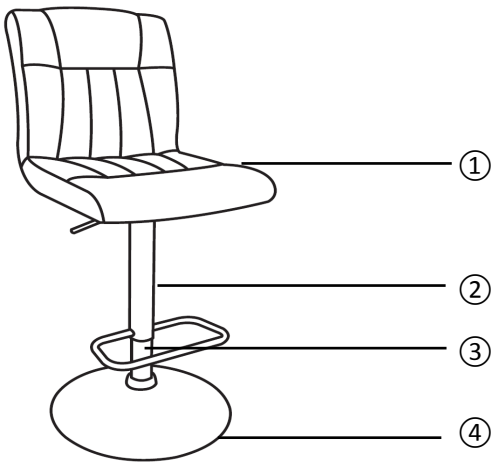
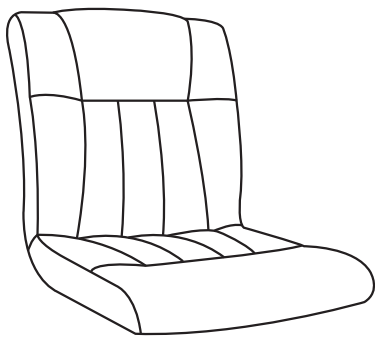

2

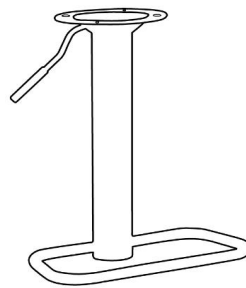

3



4

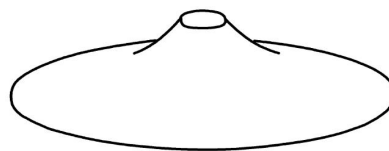

1	1x
2	1x
3	1x
4	1x

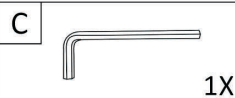
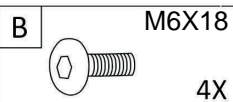
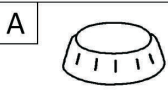

I.

1.

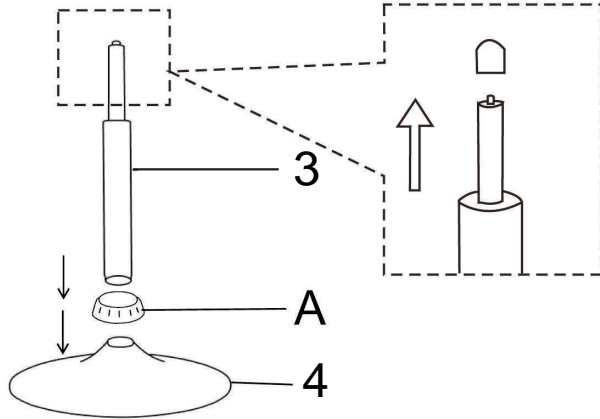

A		1X

2.

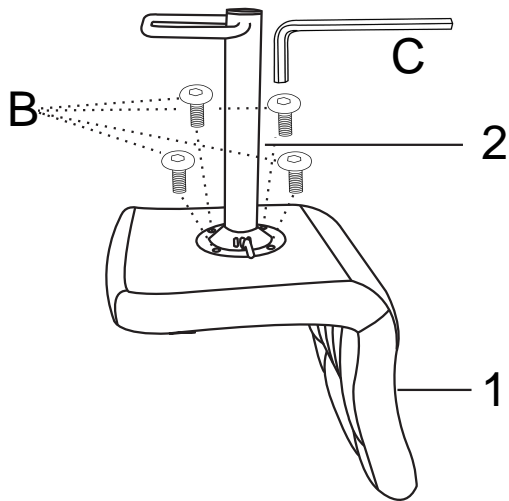

B	M6X18	4X
C		1X

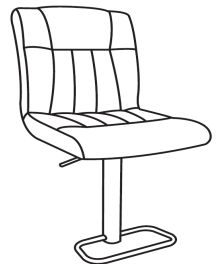

3.

