

Elif

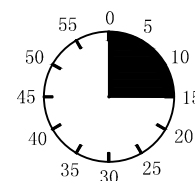
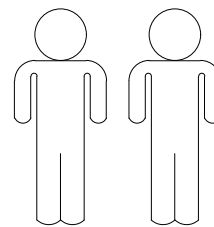
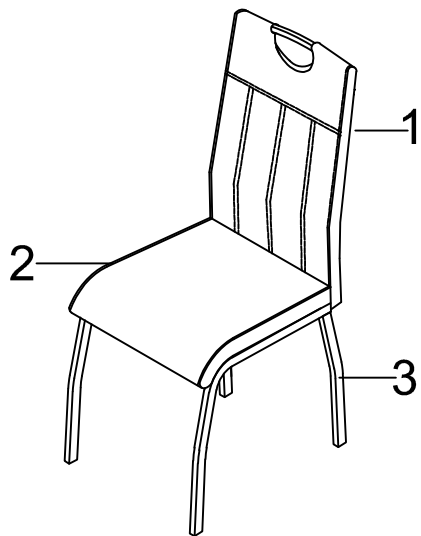

1

2

3

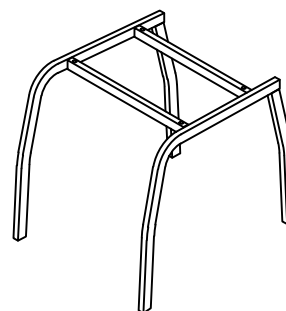
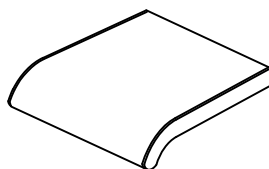
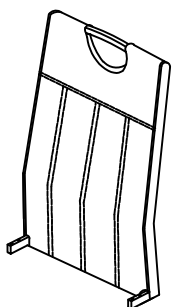

1	1X
2	1X
3	1X



1/1

A M6*12



4X

B M6*40

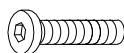

4X

C Ø16*Ø6.5*1.5



4X

D 4mm



1X

I.

1.

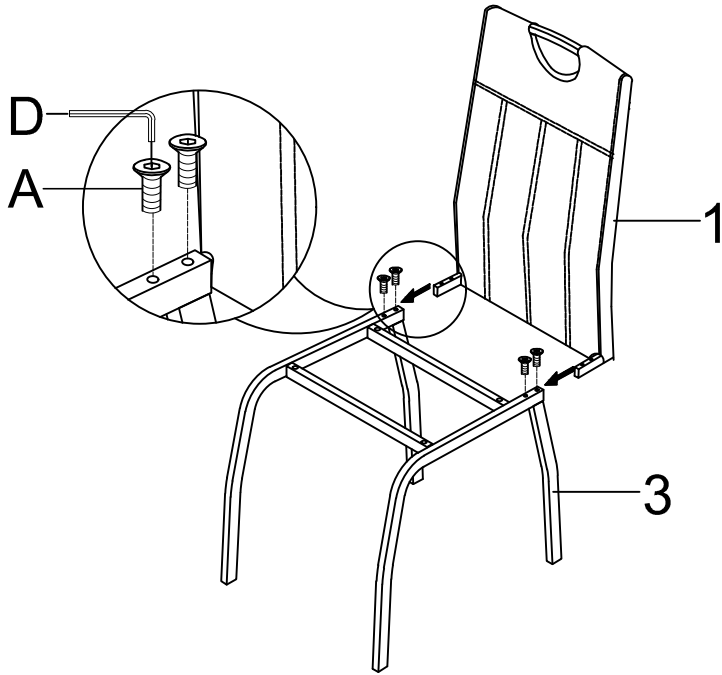

A

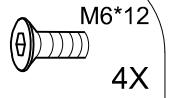

D

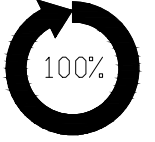
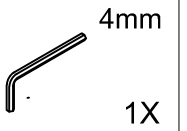

2.

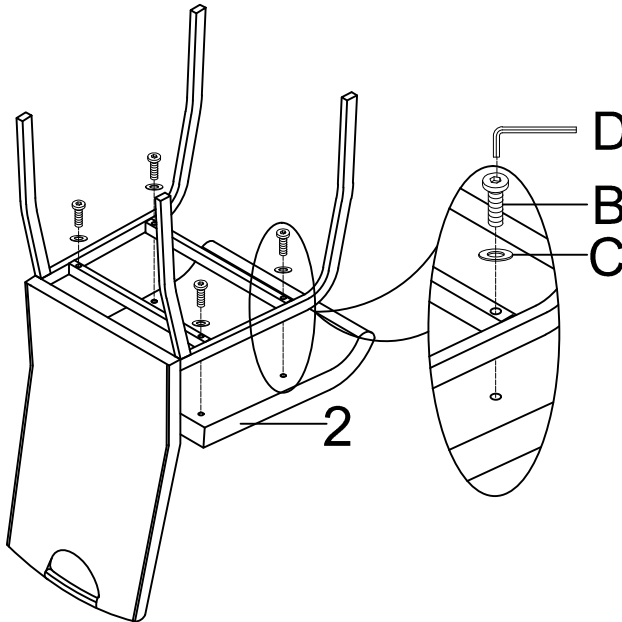

B

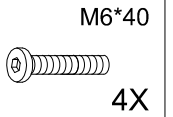

C

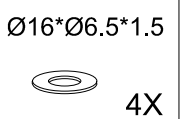

D

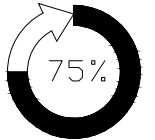
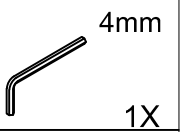

3.

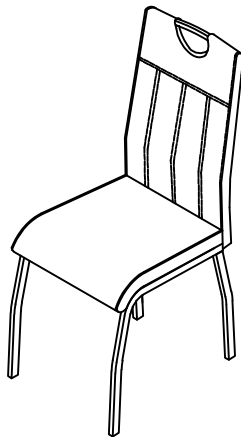

D

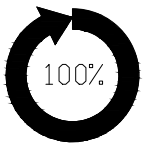
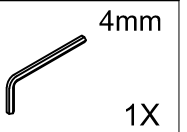

LE TRI
+ FACILE



+



Séparez les éléments avant de trier